

centor®

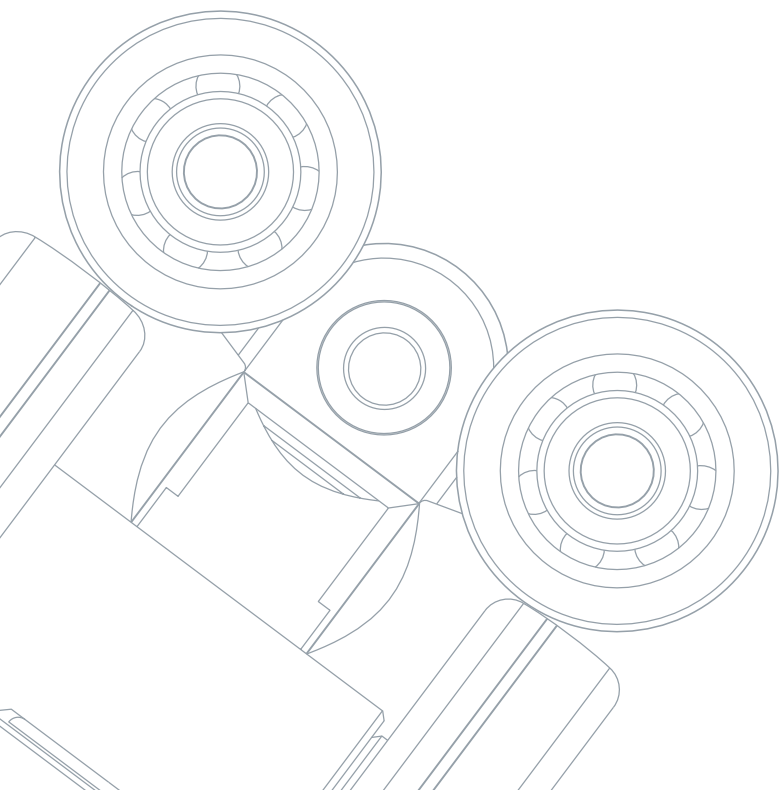

Centor E3 folding door hardware for panels to 115kg



centor®
Moved by Innovation

CONTENTS

Creating Seamless Transitions	1
Imagine The Possibilities	2
High Performance System	3
Proven Durability	5
E3 Up Close	6
E3 Assurance	7
E3 Product Details	8
Architectural Detail	9
Hardware Selection	14
Dropbolts	21
Door Size Calculation	24
Common Panel Layouts	25
Surelock™ Adjustment	28



E3 Specifications	
maximum opening width	16m
maximum panel weight	115kg each
maximum panel width	1200mm
maximum panel height	3600mm
minimum door thickness	35mm
maximum number of doors	8 each direction

Note: Specifications are intended as a guide only. Calculated weight check should be performed to ensure doors built to maximum height and width do not exceed maximum weight.

CREATING SEAMLESS TRANSITIONS

Centor E3 is a medium-heavy folding door hardware system for door panels to 115kg – Centor's solution to the challenge of creating truly seamless transitions between indoor and outdoor spaces. E3 is suitable for a range of applications from stylish private residences to the most ambitious store front, restaurant or commercial project; anywhere the ability to flexibly manage space to suit lifestyle or business is required.

Allowing for the extra weight of double-glazing, E3-based folding doors promise unprecedented insulation against noise and temperature variation when doors are closed. Likewise the ability to utilise even sturdier door construction and materials enhances security and resistance to the elements in the most exposed of applications. The renowned effortless operation of Centor products remains, even as maximum panel weight increases, making E3 the perfect way to utilise folding technology in even the toughest conditions.



APPLICATIONS ARE LIMITED ONLY BY IMAGINATION



IMAGINE THE POSSIBILITIES

Business or pleasure, E3 means entertainment without the interruption of conventional sliding or hinged doors, views which become vistas, a breeze when you please! Over the past decade Centor's groundbreaking exterior folding window and door technology has instigated a worldwide revolution in window and door installation.

One moment folding doors are acting as an effective, secure barrier from rain, wind and noise. The next they're effortlessly moved aside to reveal wide open space – with no fixed glass panels or posts. The considerable weight-bearing capacity of the elegant, precisely functioning E3 ensures that possible applications for Centor's folding range are limited only by the imaginations of the world's most progressive architects and designers.

Engineered to withstand the most severe weather, E3 is just as suited to interior use. The ability to visually and physically connect spaces can be equally beneficial indoors and the sound-proofing effect of double-glazing equally important. The benefits to the end-user in flexibly managing interior or exterior space to suit lifestyle or business are literally changing the face of contemporary building design.



HIGH PERFORMANCE SYSTEM

Interior comfort, operational function, durability; painstaking attention to detail and an unerring commitment to quality mean 'Centor-grade' performance, whatever the category. The result is a degree of control and comfort for the end-user that matches the easy flexibility of modern design.

EFFORTLESS OPERATION

While E3's outstanding performance as part of a secure, weatherproof barrier is crucial, it's not until the doors are opened that the space-transforming benefits of the system truly come into play. For maximum enjoyment and use of the system, every effort has been made to ensure that doors glide open and slide shut with the minimum of effort throughout their working life.

Quality Manufacture, Innovative Design

E3 carriers, guides and pivots use the highest grade stainless steel bearings custom machined to extremely fine tolerances on state-of-the-art German and Swiss machinery – a minimum of six bearings to each carrier. Machined wheels are individually precision ground to an ultra-fine hone. Innovative carrier design prevents scraping on the inside of the overhead track. A polypropylene floor channel lining adds to the smooth, almost silent rolling action which brings a smile to the face of the user!

Assembly and Installation

With quick-fix surface-mounted fittings assembly and installation couldn't be easier. Comprehensive instructions are included and drill jigs are available to ensure precise placement of fittings.

Adjustment

While E3 is designed to operate flawlessly well into the future, built-in adjustment mechanisms make the system tolerant of an imperfect world. Surelock™, Centor's patented carrier pin locking system ensures that once heights are set they stay set, but should door panels swell or a newly built structure settle over time, the end-user can easily make vertical and lateral adjustments simply using a screwdriver.

INTERIOR COMFORT

E3 is truly a system for all seasons and all locations. Teamed with quality door panels, E3 hardware ensures a formidable barrier against the elements when closed. The integrity of the required internal environment is never compromised.

TESTED UNDER THE TOUGHEST CONDITIONS



Rain and Wind

Centor hardware was utilised in the first tracked folding door system to be certified under Australian Standard AS2047, which specifies the weather performance required of external windows and sliding doors. Doors utilising the E3 and E4 system have since passed all tests required for product approval from Florida's meticulous Miami-Dade County testing authorities – the single toughest standard of testing anywhere in the world from a region legendary for its coastal hurricanes and seasonal weather. With the same technology built into E3 impressive water performance ratings are achievable from both outward and inward opening doors. Driving rain and howling gales can be shut out completely.

Air Infiltration

The E3 system achieves its superior rain and wind resistance in part from the way it allows the folding doors to close snugly against weather seals. In the same way doors using E3 effectively resist air infiltration to a level up to 50 times better than a conventional sliding door.

Noise and Temperature

With double or triple glazing allowed for by E3's impressive panel weight capacity, unprecedented levels of insulation against noise and temperature variation are possible.

COLLABORATIVE DESIGN PROCESS

E3's thoughtful design doesn't achieve the highest performance in all categories on its own. It's in its element teamed with the quality products created by Centor's many manufacturing and custom fabricating clients. The Centor technical department can assist in the design process for door sets incorporating the E3 system to ensure that the highest criteria for completed and installed doors are met even in the most unusual applications.



PROVEN DURABILITY

While Centor certainly enjoys its reputation for innovation, ensuring that products meet and exceed the highest standards for durability is just as much a passion. This means a significant investment in repeatedly testing systems under the toughest of conditions – then testing them again!

LABORATORY TESTING

In addition to extensive weather testing as part of complete door systems, all individual E3 components have been extensively laboratory tested, ensuring years of trouble-free enjoyment from hardware which ages with grace.

Cyclic Testing

Centor's minimum requirement of cyclic testing for any released product is a grueling 50,000 cycles without a single failure at maximum configuration. E3 has been tested in excess of 50,000 cycles with many parts rated to over 100,000 cycles.

Corrosion Testing

Stainless steel and engineering-grade plastics are used throughout the E3 system and are carefully selected to maximise performance in any environment. Centor conducts regular, thorough corrosion testing in a salt spray chamber, fixing hardware to various substrates to ensure that E3 will perform admirably even in the most exposed of coastal applications.

Structural Testing

Structural proof load tests up to 3600 Pa (74 psf) have been achieved by doors using the less substantial E2 system.

Finite Element Analysis

Finite Element Analysis (FEA) is a computerised simulation technique where products are exposed to virtual operating environments and accurate predictions made in terms of load and deflection. Centor undertakes FEA in the design process to ensure the best balance of performance, cost and materials in every system.

Hurricane Testing

In the course of obtaining approval under the stringent Miami-Dade County testing regime, doors based on the larger E4 system were subjected to hurricane strength wind loads, flexing the doors in and out five thousand times without component failure. Small and large missile impact testing was also performed as part of the single toughest testing process anywhere in the world.

TEAM WITH TIMBER, ALUMINIUM, PVC OR FIBREGLASS PANELS



E3 UP CLOSE

Even a casual glance at the E3 system gives a strong impression of Centor's commitment to quality, but it's only upon closer inspection that the attention to detail really becomes apparent. Stacked with standard features and with an abundance of options to choose from, Centor E3 looks even better up close!

Materials and Finishes

E3 carriers, guides, pivots and hinges are available in brushed stainless steel for a contemporary look, a PVD brass or PVD black finish over stainless steel should a more traditional finish be required. Head tracks and sills are produced in extruded aluminium with the option of natural, gold and bronze anodised finishes. Floor guide channels and sills are produced in aluminium in various finishes with black polypropylene liner.

Panel Size and Materials

Centor's innovative hinge system enables the use of uniform-sized door panels regardless of the door configuration ensuring maximum efficiency in door manufacture. Easily installed hardware can be teamed with door panels in timber, aluminium, PVC or fibreglass.

Design Features

A floating wall pivot is used to control door stile deflection and bowing on tall doors caused by wind loads or climatic conditions. Offset floor guides and floor pivots mean the guide channel is concealed beneath closed doors, while top-rolling function means performance is never compromised by debris in tracks.

Dropbolts

Easily installed with a dedicated router bit available from Centor, DF and DO dropbolts are available in a range of lengths and finishes to suit every E3 application. Available keyed and non-keyed, the clean-lined DF and DO dropbolts anchor doors firmly in the closed position and, together with the weather seals, eliminate rattling in strong winds.



Pair folding doors with the Centor S1E Eco-Screen

E3 ASSURANCE

If success in modern design can be measured by the degree of comfort and ease afforded to the end-user, then Centor E3 again rates highly. E3's superior function and performance goes a long way to creating a relaxed setting while a range of other measures allow the system to be utilised with complete confidence.

UNPARALLELED SECURITY

The E3 system responds to an increasingly security conscious market place with measures designed to ensure unwanted visitors are excluded – as well as the elements.

Concealed Fittings

When doors utilising E3 are closed there are no externally accessible parts that can be removed or damaged. Screw fixings are concealed.

Locking Screw Technology

The E3 system incorporates locking screw technology which ensures the E3 hardware can not be removed from the track when the doors are closed.

WARRANTY

In line with a commitment to the highest possible quality Centor offers a 10-year warranty on all E3 hardware.

For full details refer to the current Centor Catalogue, or view information online at www.centor.eu

HARDWARE SELECTION

E3 is a fully integrated system suitable for applications up to 100kg per panel in timber, aluminium, PVC or fibreglass. Architects and specifiers should feel comfortable simply specifying 'Centor E3' and leaving detailed component selection to the builder, joiner or fabricator.



E3 PRODUCT DETAILS (outward opening configuration shown)

Downloadable DXF, DWG and PDF files ready for use in your own documentation are a convenient resource for architects and specifiers wishing to use Centor systems.

E3 DXF, DWG or PDF files can be downloaded from www.centor.eu

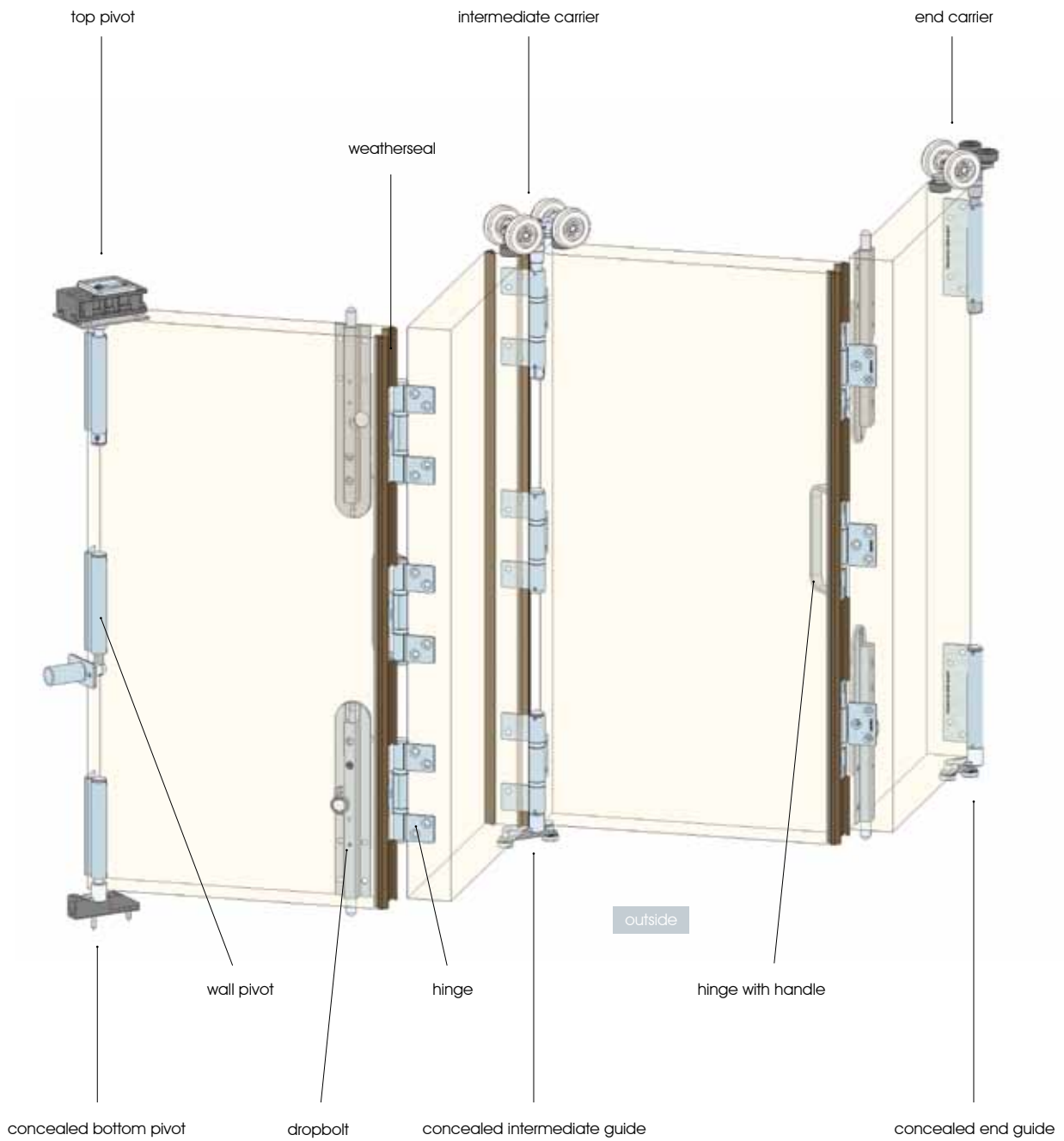

ARCHITECTURAL DETAIL

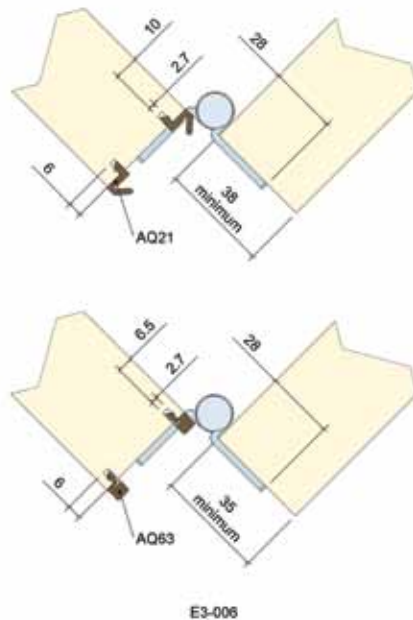
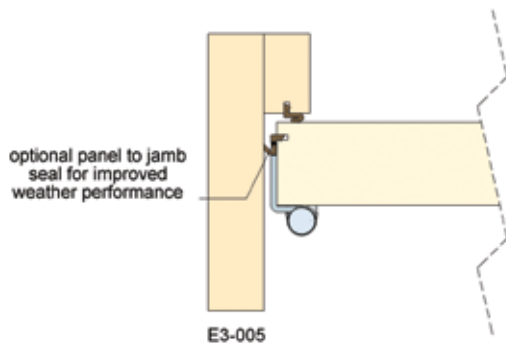
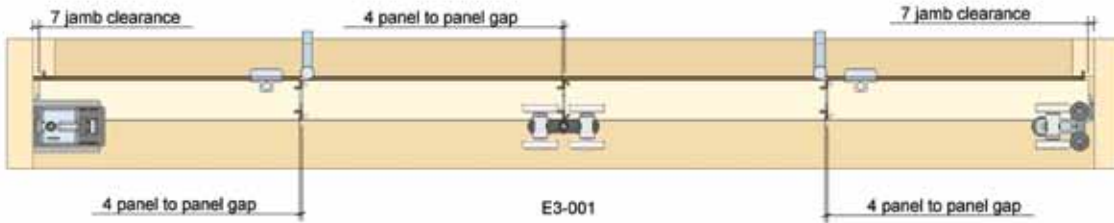

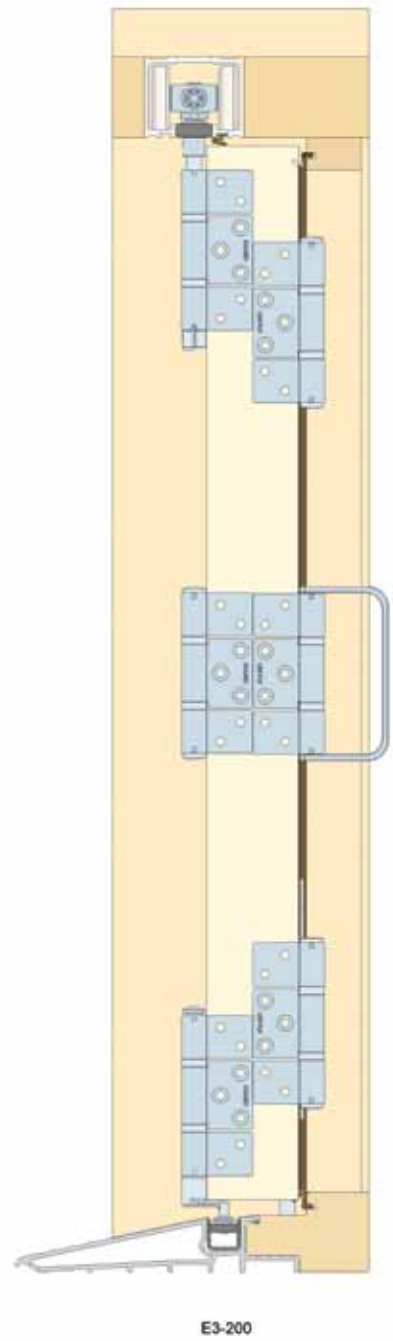
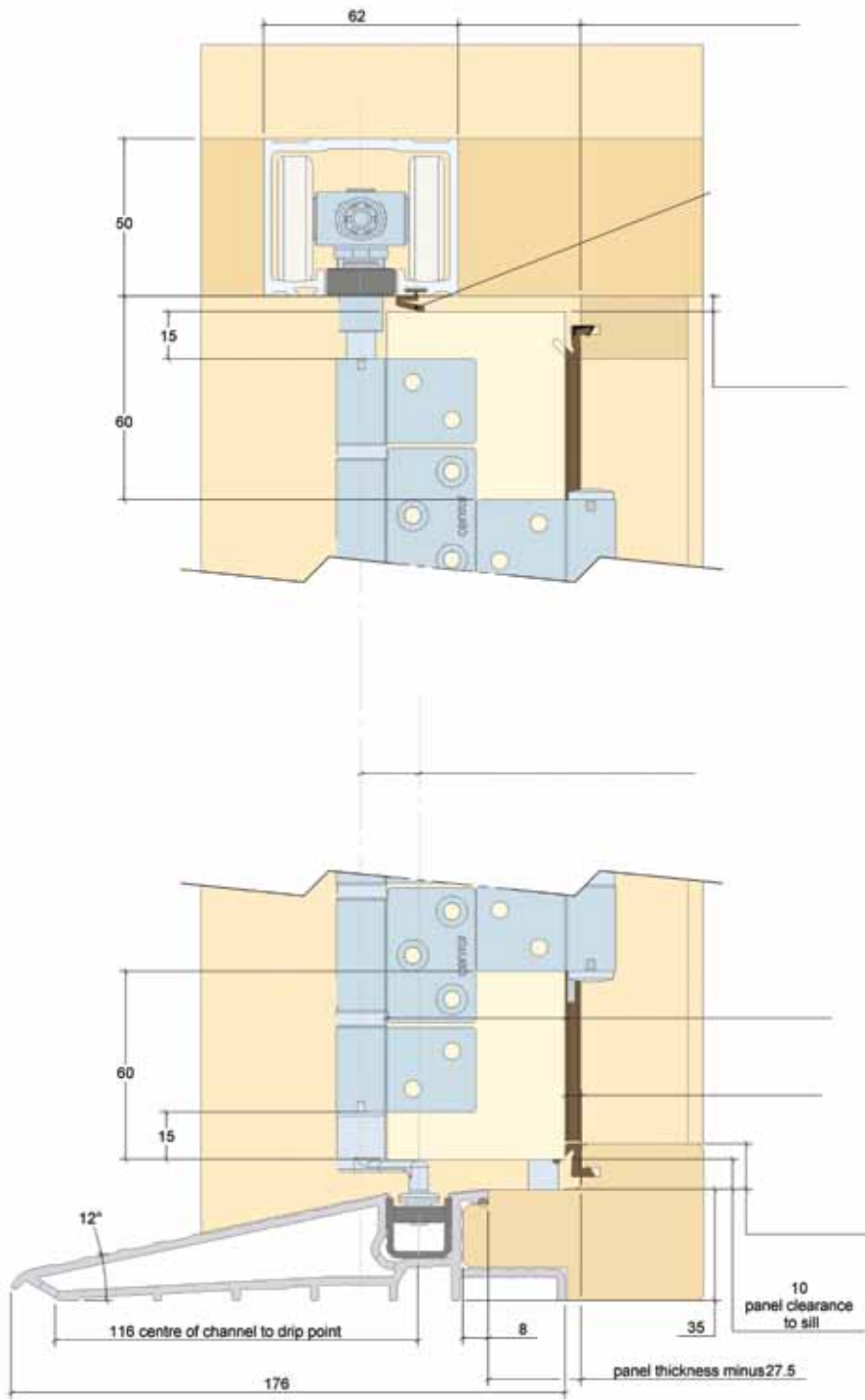

ARCHITECTURAL DETAIL

CONCEALED SELF DRAINING SILL FOR OUTWARD OPENING DOORS

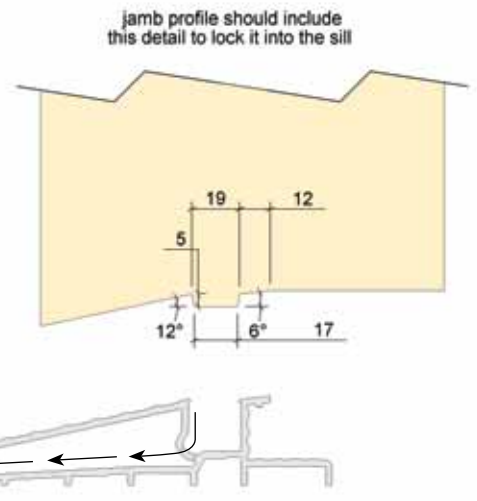
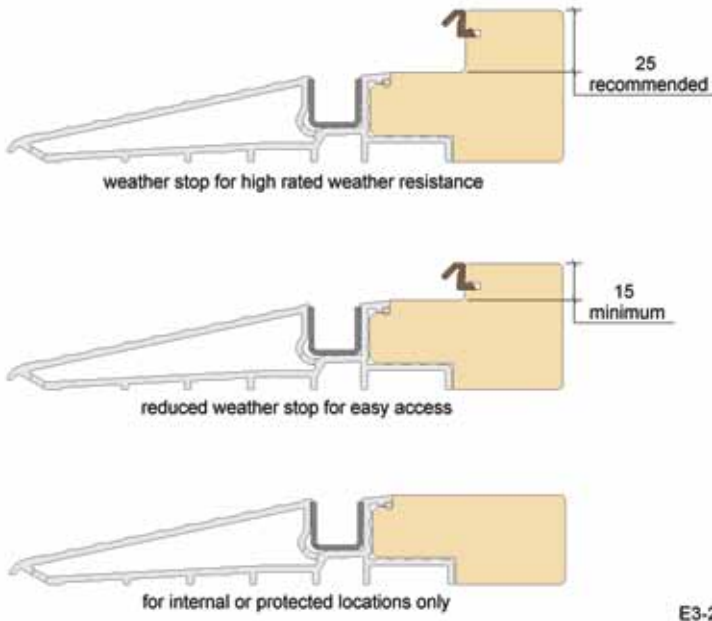

END CAP

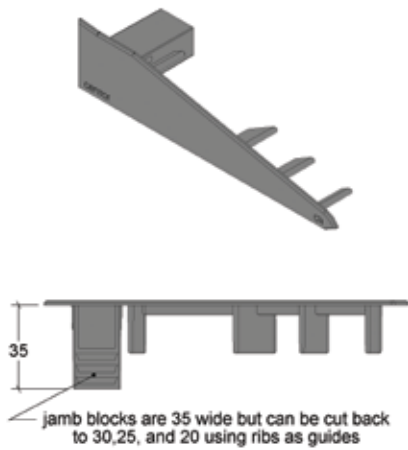

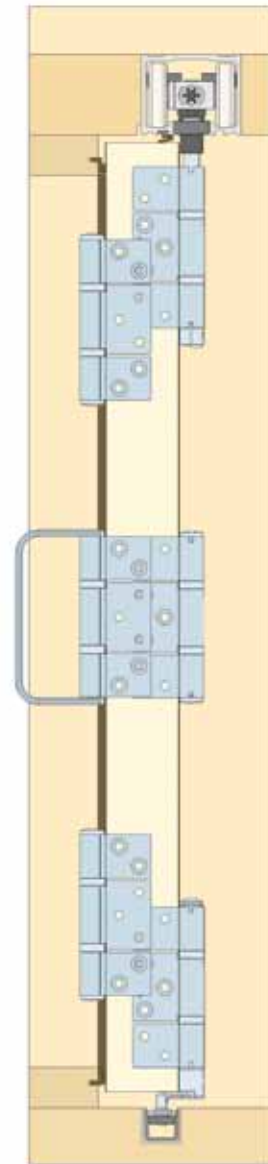
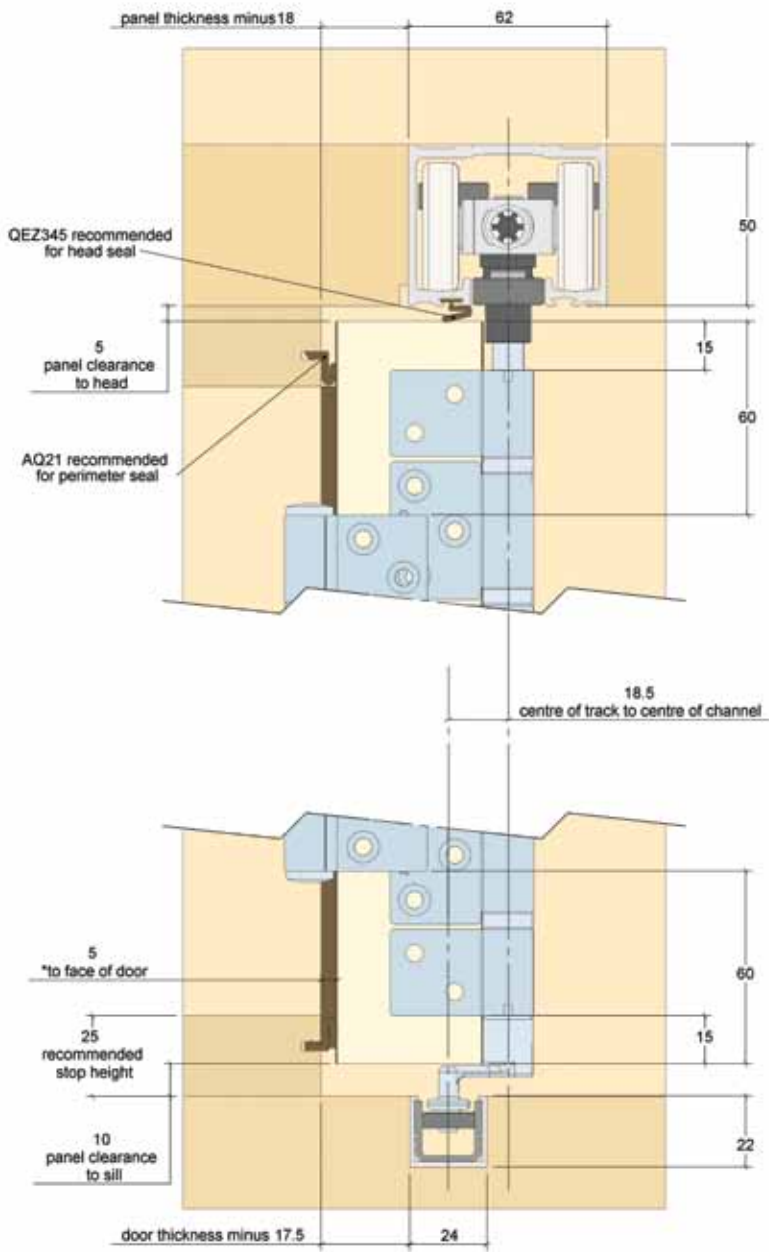

E3-004

ARCHITECTURAL DETAIL

EQUAL SIZED PANELS

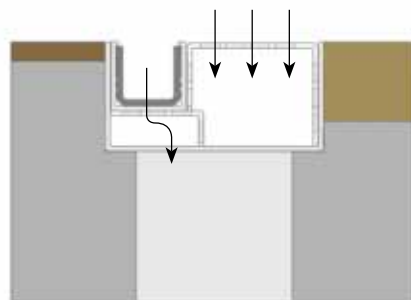
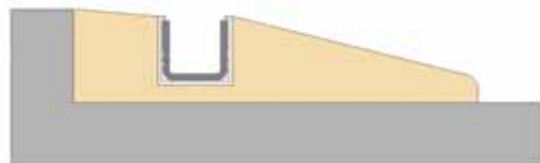
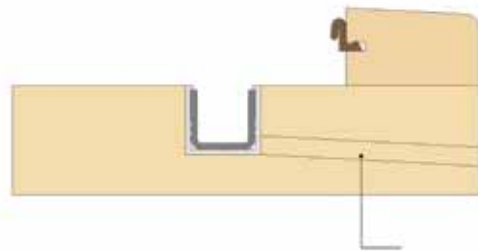
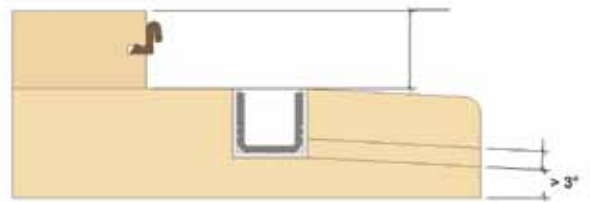
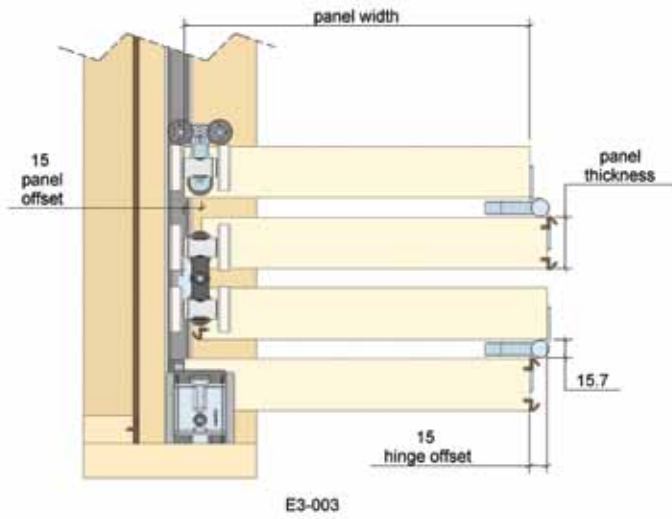

E3-006

HARDWARE SELECTION

E3 is specified with 5 separate groups:

- 1 track
- 2 sill with channel
- 3 hardware
- 4 weathersealing
- 5 dropbolts



Components are required from all 5 groups to build an E3 folding door system.

TRACK

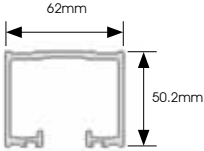
Track lengths up to 5.7m. Cut to length on application.

PART	TRACK	PRODUCT CODE	DESCRIPTION
	Aluminium track, machined	E3TAM18N	1730mm machined track, natural anodised
		E3TAM21N	2030mm machined track, natural anodised
		E3TAM24N	2330mm machined track, natural anodised
		E3TAM30N	2930mm machined track, natural anodised
		E3TAM36N	3530mm machined track, natural anodised
		E3TAM4N	4000mm machined track, natural anodised
		E3TAM42N	4130mm machined track, natural anodised
		E3TAMM57N	5700mm machined both ends track, natural anodised
		E3TAM24G	2330mm machined track, gold anodised
		E3TAM30G	2930mm machined track, gold anodised
		E3TAM4G	4000mm machined track, gold anodised
		E3TAMM57G	5700mm machined both ends track, gold anodised
		E3TAM30R	3000mm machined track, bronze anodised
		E3TAM4R	4000mm machined track, bronze anodised
		E3TAMM57R	5700mm machined both ends track, bronze anodised

OUTWARD CONCEALED SILL



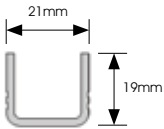
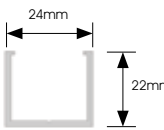

PARTS	PRODUCT CODE	DESCRIPTION
	E3CDSM36N	3600mm concealed sill, machined, natural anodised
	E3CDSM42N	4200mm concealed sill, machined, natural anodised
	E3CDSM57N	5700mm concealed sill, machined, natural anodised
	E3CDSM36R	3600mm concealed sill, machined, bronze anodised
	E3CDSM42R	4200mm concealed sill, machined, bronze anodised
	E3CDSM57R	5700mm concealed sill, machined, bronze anodised
	E3CDSEC	end cap set (left and right)

HARDWARE SELECTION

CHANNEL





PARTS	CHANNEL	PRODUCT CODE	DESCRIPTION
	Concealed channel 21mm, poly channel	E22FCP18	1800mm floor channel, polypropylene
		E22FCP21	2100mm floor channel, polypropylene
		E22FCP24	2400mm floor channel, polypropylene
		E22FCP30	3000mm floor channel, polypropylene
		E22FCP36	3600mm floor channel, polypropylene
		E22FCP4	4000mm floor channel, polypropylene
		E22FCP42	4200mm floor channel, polypropylene
		E22FCP57	5700mm floor channel, polypropylene
	Concealed channel 24mm, retainer	E22FCR24N	2400mm floor channel retainer, natural anodised
		E22FCR3N	3000mm floor channel retainer, natural anodised
		E22FCR36N	3600mm floor channel retainer, natural anodised
		E22FCR4N	4000mm floor channel retainer, natural anodised
		E22FCR57N	5700mm floor channel retainer, natural anodised
		E22FCR24G	2400mm floor channel retainer, gold anodised
		E22FCR3G	3000mm floor channel retainer, gold anodised
		E22FCR36G	3600mm floor channel retainer, gold anodised
		E22FCR4G	4000mm floor channel retainer, gold anodised
		E22FCR57G	5700mm floor channel retainer, gold anodised
		E22FCR3R	3000mm floor channel retainer, bronze anodised
		E22FCR4R	4000mm floor channel retainer, bronze anodised
		E22FCR57R	5700mm floor channel retainer, bronze anodised

WEATHERSEAL



PART	PRODUCT CODE	PART DESCRIPTION
Perimeter 	AQ21B AQ21L AQ21W	Aquamac 21 Schlegel Kerf seal, brown Aquamac 21 Schlegel Kerf seal, black Aquamac 21 Schlegel Kerf seal, white
Panel to Panel 	AQ63B AQ63L AQ63W	Aquamac 63 Schlegel Kerf seal, brown Aquamac 63 Schlegel Kerf seal, black Aquamac 63 Schlegel Kerf seal, white
Access panel 	AQ109B AQ109L AQ109W	Aquamac 109 Schlegel Kerf seal, brown Aquamac 109 Schlegel Kerf seal, black Aquamac 109 Schlegel Kerf seal, white
Head 	QEZ345B QEZ345L QEZ345W	Aquamac 345, head seal, brown Aquamac 345, head seal, black Aquamac 345, head seal, white

HARDWARE SELECTION



INTERMEDIATE CARRIER SET

PARTS	PARTS ON PANELS	PRODUCT CODE	DESCRIPTION
a) 	a) 	E3CICSS E3CICSTG E3CICSOL	concealed intermediate set, stainless steel concealed intermediate set, PVD brass concealed intermediate set, PVD black
b) 	b) 	Extra Hinge E3HNHS E3HNHTG E3HNHOL	single straight hinge, stainless steel single straight hinge, PVD brass single straight hinge, PVD black
a) Intermediate carrier set with concealed bottom guide b) Extra hinge required for doors over 2250mm			

RIGHT CARRIER SET

PARTS	PARTS ON PANELS	PRODUCT CODE	DESCRIPTION
		E3CRCSS E3CRCSTG E3CRC SOL	concealed right hand carrier set, stainless steel concealed right hand carrier set, PVD brass concealed right hand carrier set, PVD black

LEFT CARRIER SET



PARTS	PARTS ON PANELS	PRODUCT CODE	DESCRIPTION
		E3CLCSS E3CLCSTG E3CLCSOL	concealed left hand carrier set, stainless steel concealed left hand carrier set, PVD brass concealed left hand carrier set, PVD black

HARDWARE SELECTION

STRAIGHT HINGE SET

PARTS	PARTS ON PANELS	PRODUCT CODE	DESCRIPTION
a) with handle 		E3HSS E3HSTG E3HSOL	hinge set with handle, stainless steel hinge set with handle, PVD brass hinge set with handle, PVD black
b) without handle 		E3HNHSS E3HNHSTG E3HNHSOL	hinge set no handle, stainless steel hinge set no handle, PVD brass hinge set no handle, PVD black





SINGLE STRAIGHT HINGE

PARTS	PRODUCT CODE	DESCRIPTION
a) with handle 	E3HS E3HTG E3HOL	single straight hinge with handle, stainless steel single straight hinge with handle, PVD brass single straight hinge with handle, PVD black
b) without handle 	E3HNHS E3HNHTG E3HNHOL	single straight hinge no handle, stainless steel single straight hinge no handle, PVD brass single straight hinge no handle, PVD black

Extra hinge required for doors over 2250mm.



HARDWARE SELECTION

HALF OFFSET HINGE SET

PARTS	PARTS ON PANELS	PRODUCT CODE	DESCRIPTION
a) with handle 		E3HHSS E3HHSTG E3HHSOL	half offset hinge set with handle, stainless steel half offset hinge set with handle, PVD brass half offset hinge set with handle, PVD black
b) without handle 		E3HHNHSS E3HHNHSTG E3HHNH SOL	half offset hinge set no handle, stainless steel half offset hinge set no handle, PVD brass half offset hinge set no handle, PVD black

a) Half offset hinge set with handle for outward opening doors
 b) Half offset hinge set with no handle for inward opening doors

SINGLE HALF OFFSET HINGE



PARTS	PRODUCT CODE	DESCRIPTION
a) with handle 	E3HHS E3HHTG E3HHOL	single half offset hinge with handle, stainless steel single half offset hinge with handle, PVD brass single half offset hinge with handle, PVD black
b) without handle 	E3HHNHS E3HHNHSTG E3HHNHOL	single half offset hinge no handle, stainless steel single half offset hinge no handle, PVD brass single half offset hinge no handle, PVD black

Extra hinge required for doors over 2250mm.



HARDWARE SELECTION

PIVOT SET – WALL PIVOT

Wall pivots are mandatory on door panels over 2150mm. Wall pivots are strongly recommended on all door panels in wet or humid climates, exposed locations, inward opening applications and unstable timber doors. A second pivot can be used on door panels over 2250mm to match the additional row of hinges.

PARTS	PARTS ON PANELS	PRODUCT CODE	DESCRIPTION
		E3CPSS E3CPSTG E3CPSOL	concealed pivot set, stainless steel concealed pivot set, PVD brass concealed pivot set, PVD black

WALL PIVOT

PARTS	PARTS ON PANELS	PRODUCT CODE	DESCRIPTION
	a)  b) 	E3WPSS E3WPSTG E3WPSOL	wall pivot set, stainless steel wall pivot set, PVD brass wall pivot set, PVD black





- a) Pivot set and jamb mounted middle wall pivot mandatory on door panels over 2150mm to prevent/control deflection and bowing
 b) Pivot set and two wall pivots to match hinge pattern on door panels over 2250mm

DRILL JIG



PARTS	PRODUCT CODE	DESCRIPTION
	E3DJ	E3 Drill Jig

HARDWARE SELECTION

HANDLES

PARTS	PARTS ON PANELS	PRODUCT CODE	DESCRIPTION
a) face mounted 		DF1IPHS DF1IPHTG DF1IPHOL	internal pull handle, stainless steel internal pull handle, PVD brass internal pull handle, PVD black
b) edge mounted 		E3EHS E3EHTG E3EHOL	external handle, stainless steel external handle, PVD brass external handle, PVD black

ACCESSORIES

PARTS	PRODUCT CODE	DESCRIPTION
	EWMP	Magnet pack for intermediate panels (pair)
	DCAS DCATG DCAOL	door catch for access panels, stainless (pair) door catch for access panels, PVD brass (pair) door catch for access panels, PVD black (pair)

AVAILABLE IN A RANGE OF LENGTHS AND FINISHES



CENTOR DROPBOLTS

Centor's stylish, flush-mounting dropbolts have been specifically designed for use with Centor systems and to meet the unique security and weatherproofing conditions that exist with folding doors. Easily installed with a dedicated router bit available from Centor, DF, DY and DO dropbolts are available in a range of lengths and finishes to suit every application. Available keyed and non-keyed, DF, DY and DO dropbolts are keyed alike or can be re-keyed.

Centor DF

Rated to resist the most extreme wind conditions (up to 450kg in certain timbers) DF dropbolts feature rounded styling and are suited to use with outward opening folding doors. Available in 200mm, 400mm, 600mm and 1000mm lengths with a 20mm throw they come in gold anodised, brushed metallic, oil rubbed bronze and custom powdercoated finishes. Keyed DF dropbolts feature a unique folding damage-proofing mechanism which prevents the bolt being operated while the key remains in the lock.

Centor DY

Suited to outward opening folding doors, DY is rated to resist the most extreme wind conditions (up to 450kg in certain timbers). DY features an extended 25mm throw and is available in an oil rubbed bronze powdercoat finish in 200mm, 400mm, 600mm and 1000mm lengths. Keyed DY dropbolts feature a unique folding damage-proofing mechanism which prevents the bolt being operated while the key remains in the lock.

Centor DO

Offering all the style, security and choice of DF, DO dropbolts suit inward opening doors based on the E3 Concealed system. DO is installed at the top of the door panel while DO Concealed locks into the floor channel of the folding system, meaning no extra holes or slots to drill or machine in the floor surface or door-sill. DO comes in gold anodised, brushed metallic, oil rubbed bronze and custom powdercoated finishes.



Centor DF dropbolt



Centor DO dropbolt

DROPBOLTS / OUTWARD OPENING DOORS

DF and DY / KEYED

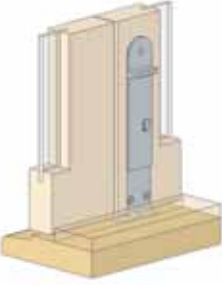
PARTS	ARCHITECTURAL DETAIL	PRODUCT CODE	DESCRIPTION
		DBFO200KRG	200mm DF dropbolt, keyed, gold anodised
		DBFO200KRX	200mm DF dropbolt, keyed, brushed metallic
		DBFO400KRG	400mm DF dropbolt, keyed, gold anodised
		DBFO400KRX	400mm DF dropbolt, keyed, brushed metallic
		DBFO600KRG	600mm DF dropbolt, keyed, gold anodised
		DBFO600KRX	600mm DF dropbolt, keyed, brushed metallic
		DBFO1000KRX	1000mm DF dropbolt, keyed, brushed metallic
		DBSY200KRQ	200mm DY dropbolt, keyed, oil rubbed bronze powdercoat
		DBSY400KRQ	400mm DY dropbolt, keyed, oil rubbed bronze powdercoat
		DBSY600KRQ	600mm DY dropbolt, keyed, oil rubbed bronze powdercoat
		DBSY1000KRQ	1000mm DY dropbolt, keyed, oil rubbed bronze powdercoat

DF and DY / NON-KEYED

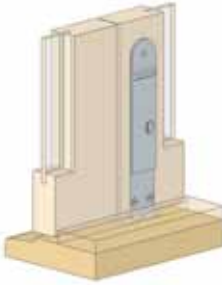
PARTS	ARCHITECTURAL DETAIL	PRODUCT CODE	DESCRIPTION
		DBFO200NRG	200mm DF dropbolt, non-keyed, gold anodised
		DBFO200NRX	200mm DF dropbolt, non-keyed, brushed metallic
		DBFO400NRG	400mm DF dropbolt, non-keyed, gold anodised
		DBFO400NRX	400mm DF dropbolt, non-keyed, brushed metallic
		DBFO600NRG	600mm DF dropbolt, non-keyed, gold anodised
		DBFO600NRX	600mm DF dropbolt, non-keyed, brushed metallic
		DBFO1000NRX	1000mm DF dropbolt, non-keyed, brushed metallic
		DBSY200NRQ	200mm DY dropbolt, non-keyed, oil rubbed bronze powdercoat
		DBSY400NRQ	400mm DY dropbolt, non-keyed, oil rubbed bronze powdercoat
		DBSY600NRQ	600mm DY dropbolt, non-keyed, oil rubbed bronze powdercoat
		DBSY1000NRQ	1000mm DY dropbolt, non-keyed, oil rubbed bronze powdercoat

Chrome, natural anodised and custom powdercoat available by special order.

ROUTER BIT

PART	PRODUCT CODE	DESCRIPTION
	DBFORB	dedicated router bit for professional installation of Centor DH, DF, DL, DY and DO dropbolts

CUPS

PART	PRODUCT CODE	DESCRIPTION
	DBCS	dropbolt cup, stainless steel
	DBCQ	dropbolt cup, oil rubbed bronze powdercoat
	DBCB	dropbolt cup, brass

DROPBOLTS / INWARD OPENING DOORS

DO_e / KEYED

PARTS	PRODUCT CODE	DESCRIPTION
	DBOE200KRG	200mm, keyed, gold anodised
	DBOE200KRQ	200mm, keyed, oil rubbed bronze powdercoat
	DBOE200KRX	200mm, keyed, brushed metallic
	DBOE400KRG	400mm, keyed, gold anodised
	DBOE400KRX	400mm, keyed, brushed metallic
	DBOE600KRG	600mm, keyed, gold anodised
	DBOE600KRX	600mm dropbolt, keyed, brushed metallic

DO_e / NON-KEYED

PARTS	PRODUCT CODE	DESCRIPTION
	DBOE200NRG	200mm, non-keyed, gold anodised
	DBOE200NRQ	200mm, non-keyed, oil rubbed bronze powdercoat
	DBOE200NRX	200mm, non-keyed, brushed metallic
	DBOE400NRG	400mm, non-keyed, gold anodised
	DBOE400NRQ	400mm, non-keyed, oil rubbed bronze powdercoat
	DBOE400NRX	400mm, non-keyed, brushed metallic
	DBOE600NRG	600mm, non-keyed, gold anodised
	DBOE600NRQ	600mm, non-keyed, oil rubbed bronze powdercoat
	DBOE600NRX	600mm, non-keyed, brushed metallic
	DBOE1000NRG	1000mm, non-keyed, gold anodised
	DBOE1000NRQ	1000mm, non-keyed, oil rubbed bronze powdercoat
	DBOE1000NRX	1000mm, non-keyed, brushed metallic

Chrome, natural anodised and custom powdercoat available by special order.

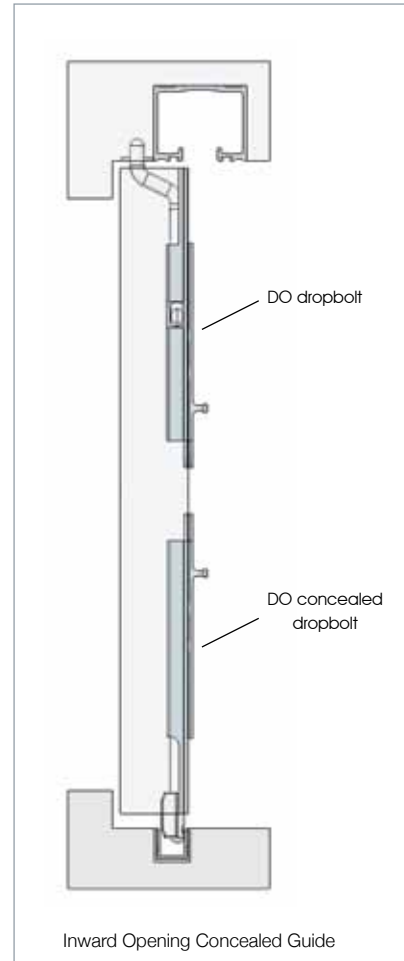

DO_c / KEYED (BOTTOM OF DOORS, FOR CONCEALED FLOOR CHANNEL)

PARTS	PRODUCT CODE	DESCRIPTION
	DBOC200KRG	200mm, concealed, keyed, gold anodised
	DBOC200KRQ	200mm, concealed, keyed, oil rubbed bronze powdercoat
	DBOC200KRX	200mm, concealed, keyed, brushed metallic

DO_c / NON-KEYED (BOTTOM OF DOORS, FOR CONCEALED FLOOR CHANNEL)

PARTS	PRODUCT CODE	DESCRIPTION
	DBOC200NRG	200mm, concealed, non-keyed, gold anodised
	DBOC200NRQ	200mm, concealed, non-keyed, oil rubbed bronze powdercoat
	DBOC200NRX	200mm, concealed, non-keyed, brushed metallic

DOOR SIZE CALCULATION

To calculate the dimensions of the doors or openings we strongly recommend using Centor's "Doorcalc" program, a Microsoft Excel spreadsheet, available at www.centor.eu. To manually calculate door sizing for an opening, follow the following steps:

- 1 Prepare a basic sketch of your door opening (see worked example), to visualize clearances and check sizes.
- 2 The calculation is based on all panels being equal width, using half-offset hinges. Note that the allowance between each panel is 4mm although hinge thickness is less – this allowance has been determined by consultation with fabricators as the best approximation for calculation. Clearance between hinges and hinge pins, coupled with the pressure from compression seals accounts for the allowance being larger than the nominal hinge flap thickness.

3 Recommended clearances are as follows;

- Jamb to panel (door closed) 7 mm
- Panel to panel (door closed) 4 mm
- Top of panel to head 5 mm
- Bottom of panel to sill 10 mm

4 Panel width	W
Opening width	L
Total number of panels	N
Panel width is:	$\frac{W = L - 14 - (4 \times (N - 1))^{**}}{N}$

Worked Examples

Clear opening size 2425 high x 4200 wide (L), and a 3L x 2R arrangement.

$$\frac{W = 4200 - 14 - (4 \times (5 - 1))}{5}$$

$$W = 834 \text{ mm}$$

Check against your door layout:

$$L = 2(7.0) + 4(4) + 5(834) = 4200 \text{ (OK)}$$

The panel height is the opening height less the nominal top and bottom clearances:

$$\text{Panel Height } H = 2425 - 10 - 10 = 2410\text{mm}$$

**** Note:** for even sets, eg 2L2R or 4L2R, the meeting gap would be larger – double seals are used to close the gap.

$$\frac{W = L - 14 - (4 \times N)}{N}$$

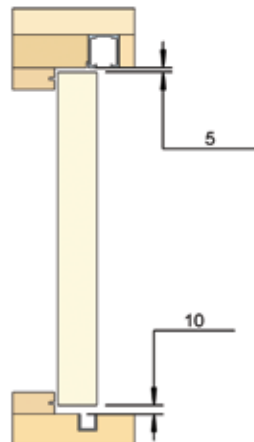

Note: Special amendments should be made for thick panels, narrow panels, even number configurations, and doors likely to expand by more than 1mm per panel.

COMMON PANEL LAYOUTS

HARDWARE LEGEND	
PS pivot set	RCS right carrier set
WPS wall pivot set	HHS half offset hinge set
ICS intermediate carrier set	HS hinge set (straight)
LCS left carrier set	DB dropbolt
IPH internal pull handle	EH external handle

LEGEND	
Passage set / Lock by other	
Dropbolts top and bottom	

> Note: Wall Pivot Set recommended for doors over 2250mm in height.

HARDWARE APPLICATION (3L2R)

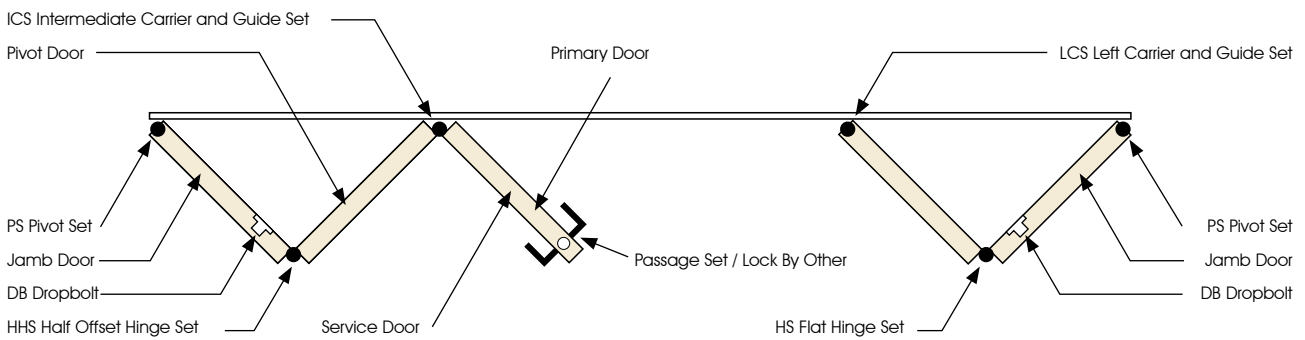

OUTWARD APPLICATION EXTERIOR HANDLE OPTION

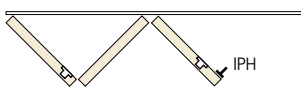

Use one interior pull handle on exit door (outswing system) where passage set / lock not required. Use dropbolts top and bottom to lock door from the inside only.

> Note Exit door not accessible from exterior in this application.

INWARD APPLICATION EXTERIOR HANDLE OPTION

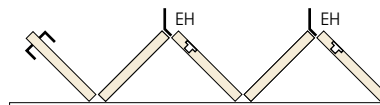

Use one exterior handle on each pair of doors (inswing system) to pull open and close doors

TWO FLOATING DOOR

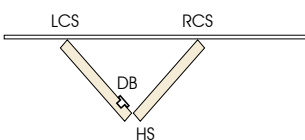

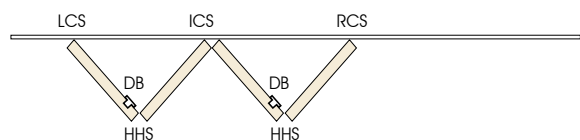

FOUR FLOATING DOOR

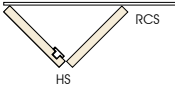
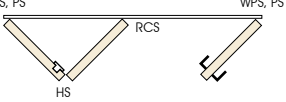
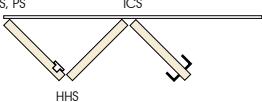
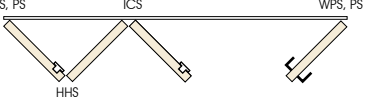
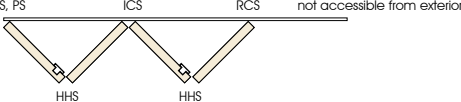
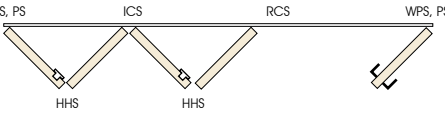

COMMON PANEL LAYOUTS

Any panel combination up to 8 in each direction is possible

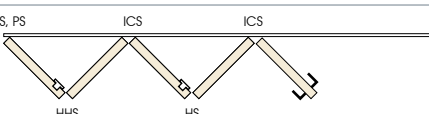
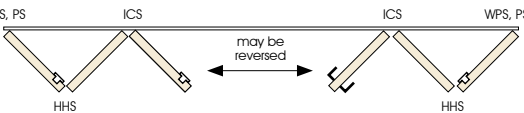
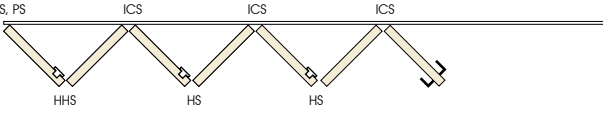
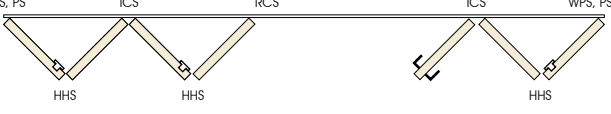
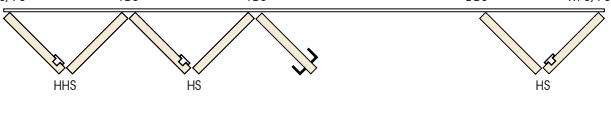
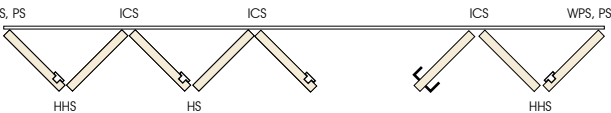
CODE	OPENING CONFIGURATION	HARDWARE
2L	<p>inside WPS, PS not accessible from exterior</p> <p>outside </p>	<p>1 x pivot set 1 x wall pivot set 1 x right carrier set 1 x hinge set 2 x dropbolt</p>
2L1R	<p>inside WPS, PS WPS, PS</p> <p>outside </p>	<p>2 x pivot set 2 x wall pivot set 1 x right carrier set 1 x hinge set 2 x dropbolt</p>
3L	<p>inside WPS, PS ICS</p> <p>outside </p>	<p>1 x pivot set 1 x wall pivot set 1 x intermediate carrier set 1 x half offset hinge set 2 x dropbolt</p>
3L1R	<p>inside WPS, PS ICS WPS, PS</p> <p>outside </p>	<p>2 x pivot set 2 x wall pivot set 1 x intermediate carrier set 1 x half offset hinge set 4 x dropbolt</p>
4L	<p>inside WPS, PS ICS RCS not accessible from exterior</p> <p>outside </p>	<p>1 x pivot set 1 x wall pivot set 1 x intermediate carrier set 1 x right carrier set 2 x half offset hinge set 4 x dropbolt</p>
4L1R	<p>inside WPS, PS ICS RCS WPS, PS</p> <p>outside </p>	<p>2 x pivot set 2 x wall pivot set 1 x intermediate carrier set 1 x right carrier set 2 x half offset hinge set 4 x dropbolt</p>
3L2R	<p>inside WPS, PS ICS LCS WPS, PS</p> <p>outside </p>	<p>2 x pivot set 2 x wall pivot set 1 x intermediate carrier set 1 x left carrier set 1 x hinge set 1 x half offset hinge set 4 x dropbolt</p>
5L	<p>inside WPS, PS ICS ICS</p> <p>outside </p>	<p>1 x pivot set 1 x wall pivot set 2 x intermediate carrier set 1 x hinge set 1 x half offset hinge set 4 x dropbolt</p>
3L3R	<p>inside WPS, PS ICS ICS WPS, PS</p> <p>outside </p> <p style="text-align: center;">← may be reversed →</p>	<p>2 x pivot set 2 x wall pivot set 2 x intermediate carrier set 2 x half offset hinge set 6 x dropbolt</p>
7L	<p>inside WPS, PS ICS ICS ICS</p> <p>outside </p>	<p>1 x pivot set 1 x wall pivot set 3 x intermediate carrier set 2 x hinge set 1 x half offset hinge set 6 x dropbolt</p>
4L3R	<p>inside WPS, PS ICS RCS ICS WPS, PS</p> <p>outside </p>	<p>2 x pivot set 2 x wall pivot set 2 x intermediate carrier set 1 x right carrier set 3 x half offset hinge set 6 x dropbolt</p>
5L2R	<p>inside WPS, PS ICS ICS LCS WPS, PS</p> <p>outside </p>	<p>2 x pivot set 2 x wall pivot set 2 x intermediate carrier set 1 x left carrier set 2 x hinge set 1 x half offset hinge set 6 x dropbolt</p>
5L3R	<p>inside WPS, PS ICS ICS ICS WPS, PS</p> <p>outside </p>	<p>2 x pivot set 2 x wall pivot set 3 x intermediate carrier set 1 x hinge set 2 x half offset hinge set 8 x dropbolt</p>

COMMON PANEL LAYOUTS

Any panel combination up to 8 in each direction is possible

CODE	OUTWARD OPENING CONFIGURATION	HARDWARE
2R	<p>inside PS, WPS not accessible from exterior</p> <p>outside LCS HS</p>	1 x pivot set 1 x wall pivot set 1 x left carrier set 1 x hinge set 2 x dropbolt
1L2R	<p>inside WPS, PS WPS, PS</p> <p>outside LCS HS</p>	2 x pivot set 2 x wall pivot set 1 x left carrier set 1 x hinge set 2 x dropbolt
3R	<p>inside ICS WPS, PS</p> <p>outside HHS</p>	1 x pivot set 1 x wall pivot set 1 x intermediate carrier set 1 x half offset hinge set 2 x dropbolt
1L3R	<p>inside WPS, PS ICS WPS, PS</p> <p>outside HHS</p>	2 x pivot set 2 x wall pivot set 1 x intermediate carrier set 1 x half offset hinge set 4 x dropbolt
2L2R	<p>inside WPS, PS RCS LCS WPS, PS not accessible from exterior</p> <p>outside HS HS</p>	2 x pivot set 2 x wall pivot set 1 x right carrier set 1 x left carrier set 2 x hinge set 4 x dropbolt
1L4R	<p>inside WPS, PS LCS ICS WPS, PS</p> <p>outside HHS HHS</p>	2 x pivot set 2 x wall pivot set 1 x intermediate carrier set 1 x left carrier set 2 x half offset hinge set 4 x dropbolt
4R	<p>inside LCS ICS WPS, PS not accessible from exterior</p> <p>outside HHS HHS</p>	1 x pivot set 1 x wall pivot set 1 x intermediate carrier set 1 x left carrier set 2 x half offset hinge set 4 x dropbolt
2L3R	<p>inside WPS, PS RCS ICS WPS, PS</p> <p>outside HS HHS</p>	2 x pivot set 2 x wall pivot set 1 x intermediate carrier set 1 x right carrier set 1 x hinge set 1 x half offset hinge set 4 x dropbolt
5R	<p>inside ICS ICS WPS, PS</p> <p>outside HS HHS</p>	1 x pivot set 1 x wall pivot set 2 x intermediate carrier set 1 x hinge set 1 x half offset hinge set 4 x dropbolt
3L4R	<p>inside WPS, PS ICS LCS ICS WPS, PS</p> <p>outside HHS HHS HHS</p>	2 x pivot set 2 x wall pivot set 2 x intermediate carrier set 1 x left carrier set 3 x half offset hinge set 6 x dropbolt
7R	<p>inside ICS ICS ICS WPS, PS</p> <p>outside HS HS HHS</p>	1 x pivot set 1 x wall pivot set 3 x intermediate carrier set 2 x hinge set 1 x half offset hinge set 6 x dropbolt
2L5R	<p>inside WPS, PS RCS ICS ICS WPS, PS</p> <p>outside HS HS HHS</p>	2 x pivot set 2 x wall pivot set 2 x intermediate carrier set 1 x right carrier set 2 x hinge set 1 x half offset hinge set 6 x dropbolt
8R	<p>inside LCS ICS ICS ICS WPS, PS not accessible from exterior</p> <p>outside HHS HS HS HHS</p>	1 x pivot set 1 x wall pivot set 3 x intermediate carrier set 1 x left carrier set 2 x hinge set 2 x half offset hinge set 8 x dropbolt

SURELOCK™ ADJUSTMENT

Surelock™ is Centor's patented carrier pin locking system which ensures that once door heights are set at the top pivots, intermediate and end carriers, they stay set!

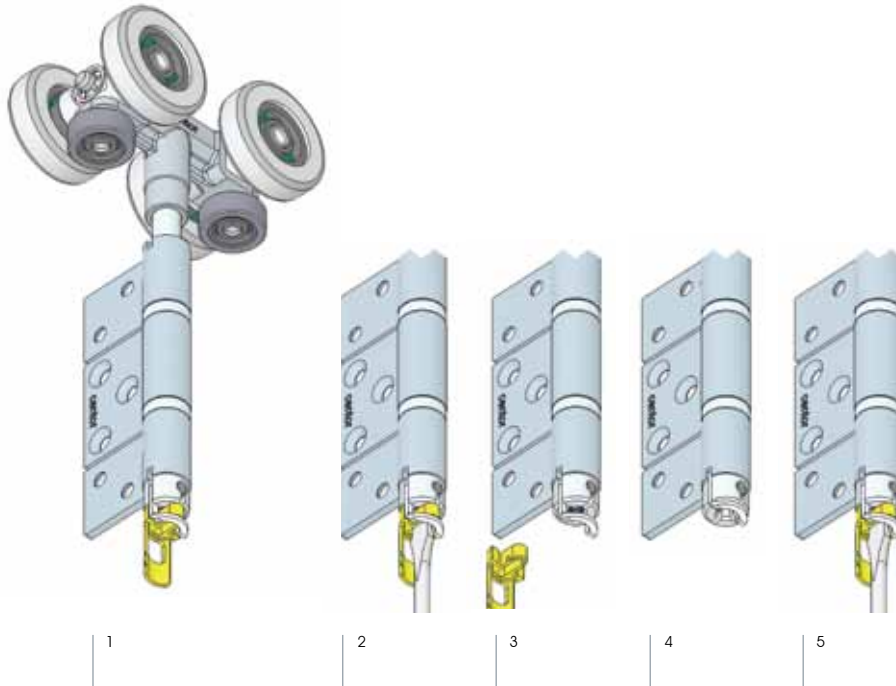

Using Surelock™ is simple

- 1 Components come supplied with a plastic shipping clip installed.
- 2 Insert a flat-bladed screwdriver into the slot and rotate the pin.
- 3 When correct adjustment is reached remove the shipping clip.
- 4 Surelock™ will snap into place when the blade and slot are aligned.
- 5 To readjust pull the blade down to disengage it from the slot, replace the shipping clip and rotate the pin.

Remove shipping clip after final installation adjustment.

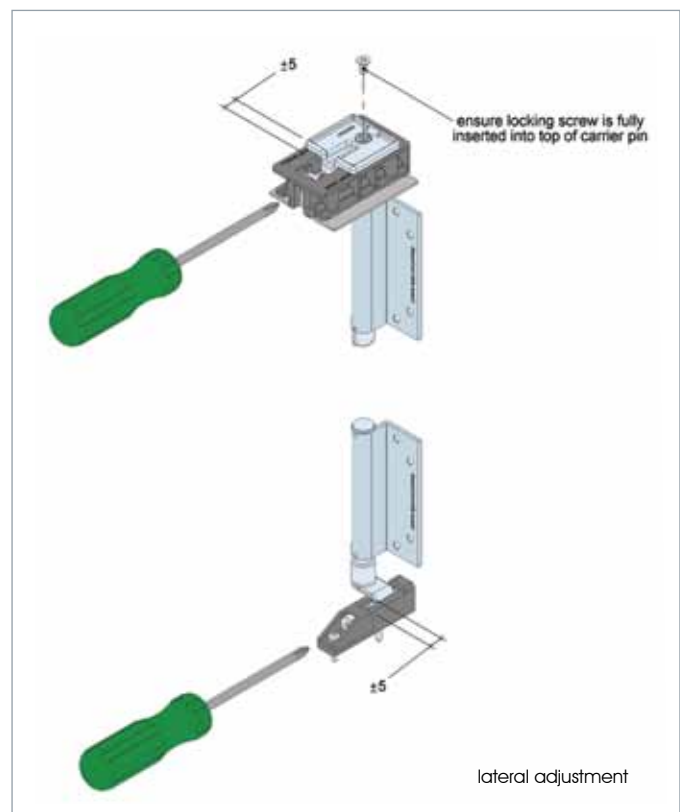

E2

E2 is a medium bifolding door hardware system for panels to 40 Kg. E2 is suitable for a range of residential and light commercial applications which do not require the extra capacity of the medium-heavy E3 or the substantial E4 heavy-duty door system. Easily installed E2 hardware can be teamed with standard door panels in timber, aluminium, PVC or fibreglass.

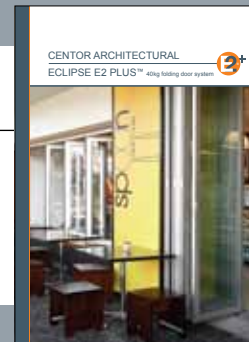

E4

Centor's most generously proportioned solution for creating seamless transitions between indoor and outdoor spaces, E4 is heavy-duty bifolding door hardware for panels to 120 Kg. E4 is suitable for openings in larger residential and commercial applications. Taller, wider door panels, expanses of framed glass; E4 provides the flexibility to manage space for lifestyle or business – on a grand scale.

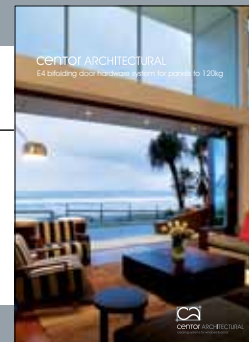

DROPBOLTS

Centor's stylish keyed and non-keyed, flush-mounting dropbolts are the ideal solution for securing or fastening in place closed folding or sliding windows and doors. Produced to Centor's exacting standards for functionality, aesthetics and longevity, seven distinctive dropbolt ranges are available in lengths, styles and finishes to suit virtually any application.



S1E Eco-Screen

The S1E Eco-Screen™ from Centor is a revolutionary product providing eco-friendly retractable insect screening and solar control with fingertip operation. This is the world's first product to offer screening solutions for openings up to 3.0m high and 7.4m wide. It is the evolution of Centor's award-winning S1 Insect Screen and offers the perfect solution to both indoor and outdoor screening problems.





2008-300-030-002

Centor Europe Ltd

610 Solar Park
Highlands Road
Solihull, B90 4SH, UK
telephone +44 (0)121 701 2500
facsimile +44 (0)121 701 2515
mail@centor.eu
www.centor.eu

centor®
Moved by Innovation